

CONDITION 1: UNDER NON-VEHICULAR TRAFFIC PAVING (SEE NOTE 6)

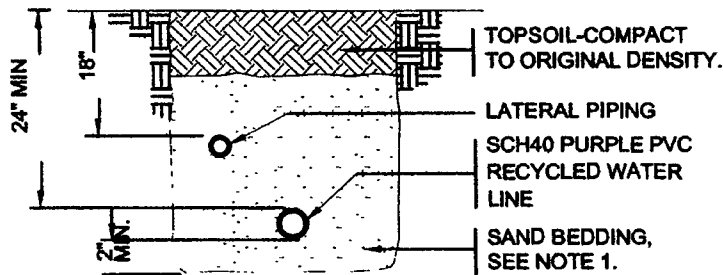

CONDITION 2: AT PLANTER IN ROCKY TERRAIN

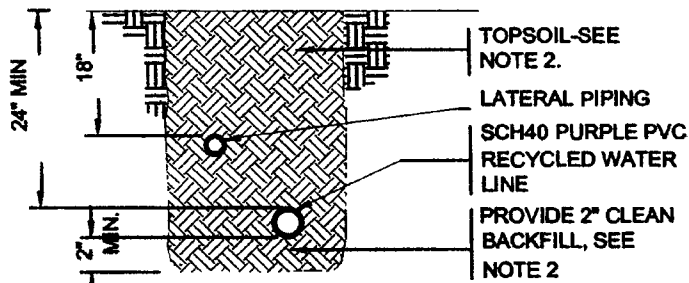

CONDITION 3: AT PLANTER AREA

TRENCHING DETAILS

Note: See Dwg RW-21C for Notes

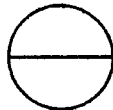

Irrigation Pipe Crossing Details  
For On-site Project

Scotts Valley Water District

Approval By:

Approval Date:

*John Plausung*  
JANUARY 2002



RECYCLED WATER USE  
CONSTRUCTION DETAILS

Revised: 1

RW-21A

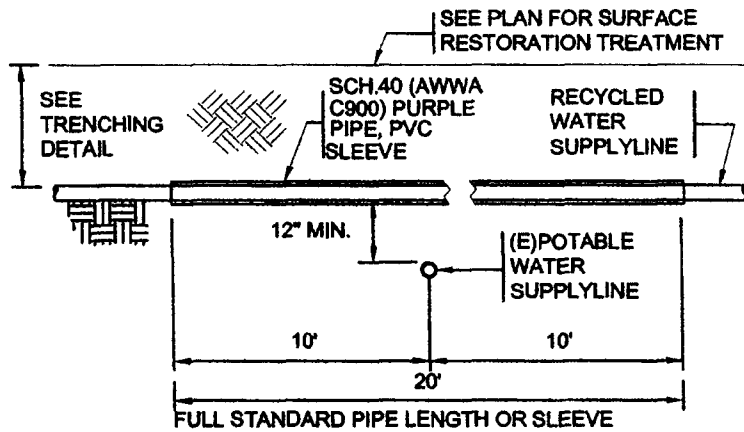
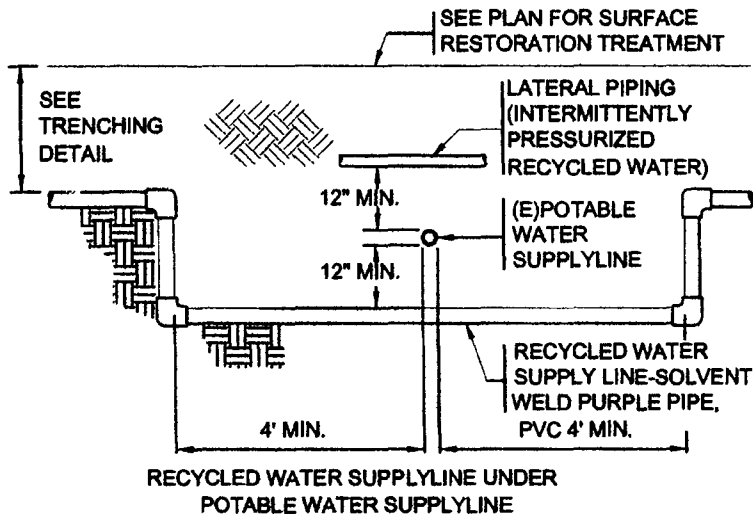

- NOTES: 1. If full pipe length not used, then sleeve.  
 2. If tie-in to existing irrigation is needed, at less than 10', then sleeve up to tie-in point.

RECYCLED WATER SUPPLYLINE OVER POTABLE WATER SUPPLYLINE

Note: See Dwg RW-21C for Notes

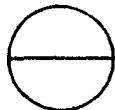

Irrigation Pipe Crossing Details  
For On-site Project

Scotts Valley Water District

Approval By: *Paul Lansing*

Approval Date: JANUARY 2002



RECYCLED WATER USE  
CONSTRUCTION DETAILS

Revision: 1

RW-21B

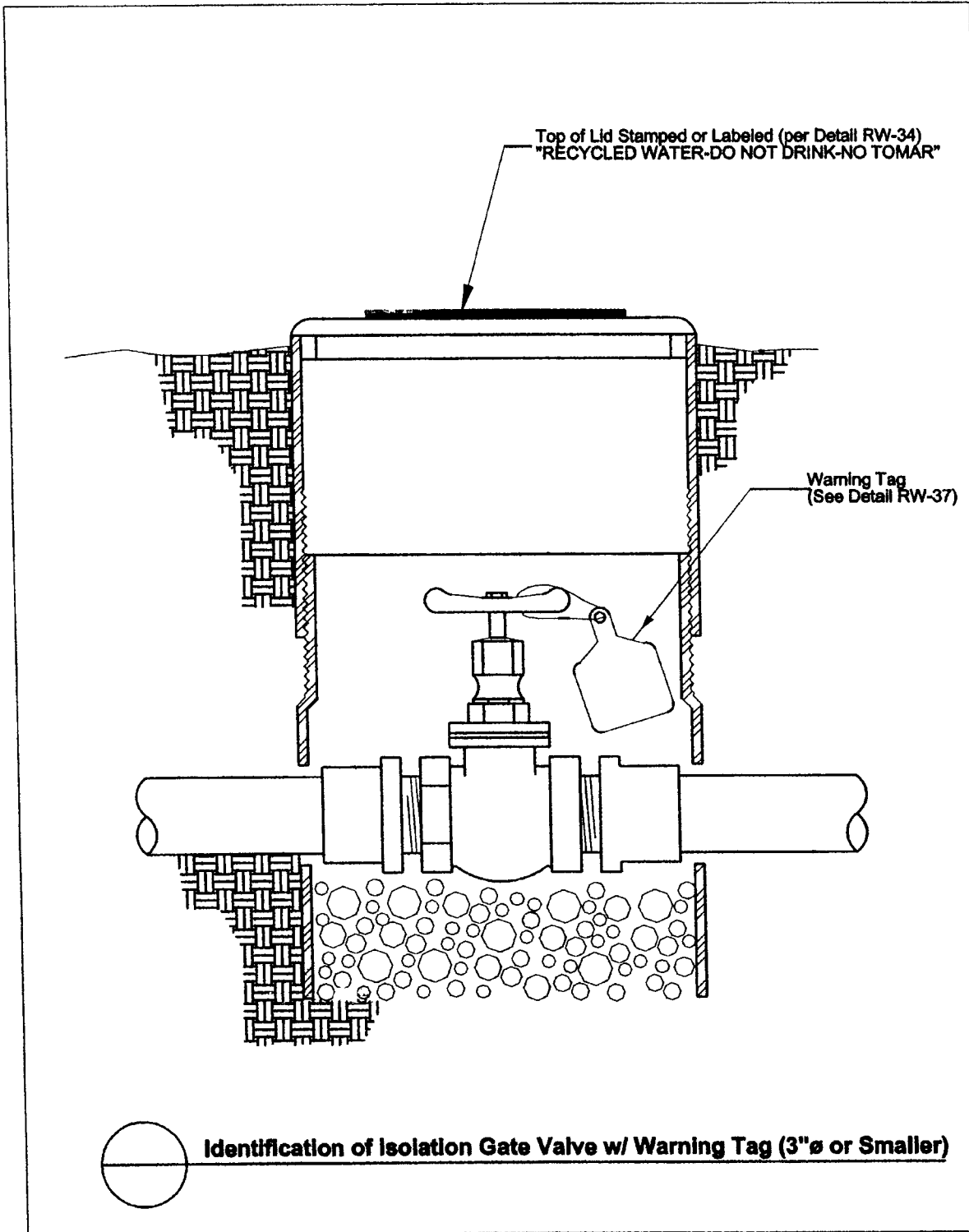

<b>Scotts Valley Water District</b>		<b>RECYCLED WATER USE SITE IDENTIFICATION DETAILS</b>
Approval By: <i>John Hansing</i> Approval Date: <i>JANUARY 2002</i>		

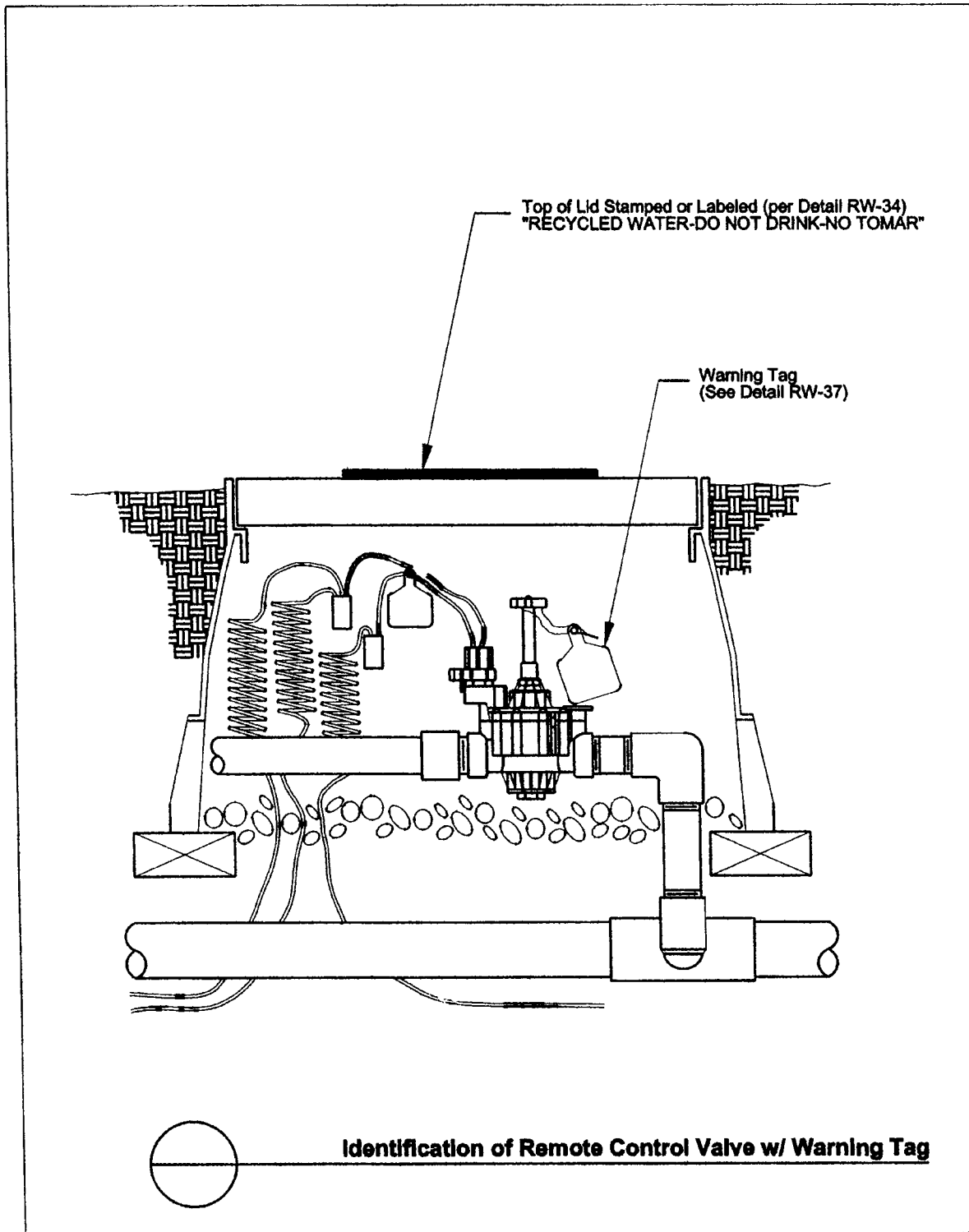

**Scotts Valley Water District**

Approval By: *John Sausung*

Approval Date: *JANUARY 2002*



**RECYCLED WATER USE SITE  
IDENTIFICATION DETAILS**

Revision: 1

RW-32

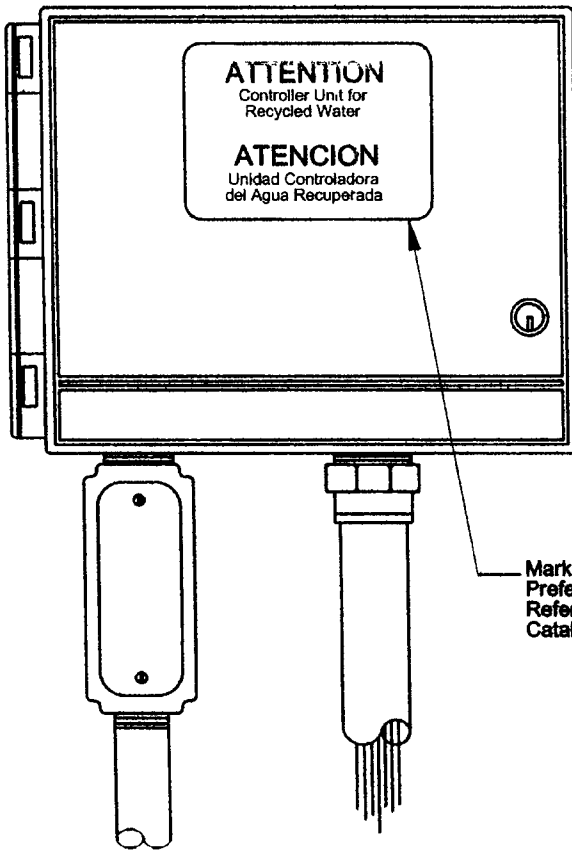

Marker Decal Shown Affixed to Box Exterior  
 Preferably, Affix to Interior of Box  
 Reference: T. Christy Enterprises, Inc.  
 Catalogy Part No. 4100 or equal.

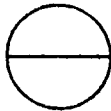

**Identification of Irrigation System Controller  
 w/ Advisory Warning Decal**

**Scotts Valley Water District**

Approval By: *Jan Paulsen*  
 Approval Date: *JANUARY 2002*



**RECYCLED WATER USE SITE  
 IDENTIFICATION DETAILS**

Revision: 1

RW-33

**DRINKING WATER COLOR: BLUE**

**RECYCLED WATER COLOR: PURPLE**

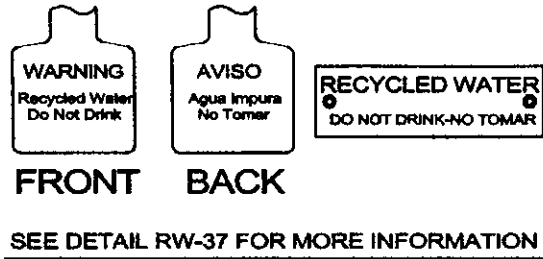
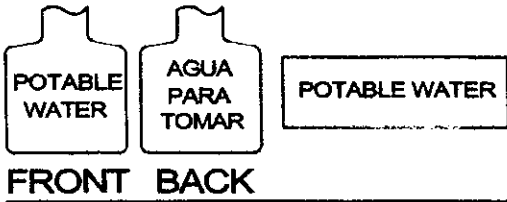

Identify Water Usage Device  
According to Type of Water Used

TYPICAL WATER SYSTEM COMPONENTS

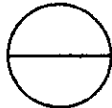
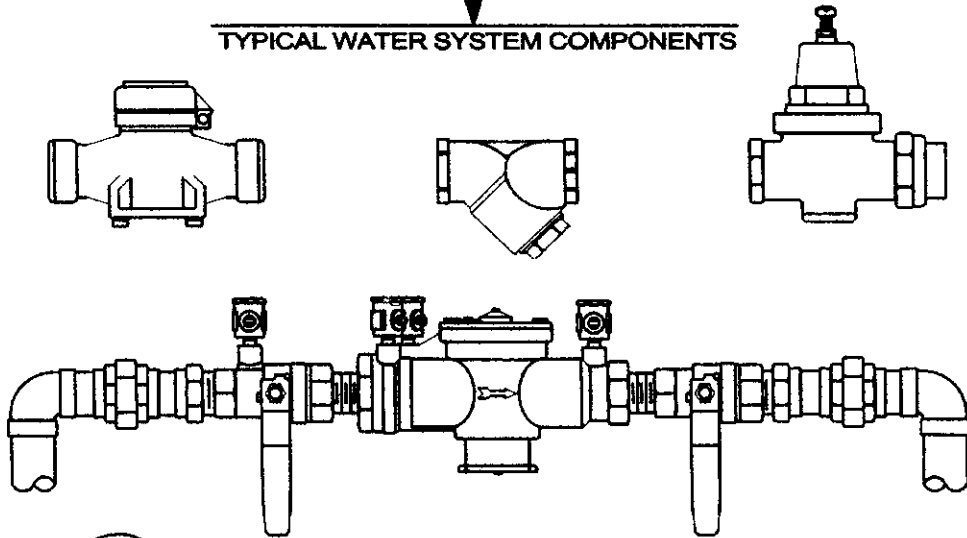

Identification of Water Control Devices w/ Warning Tag

**Scotts Valley Water District**

Approval By: *Jan Plausung*  
Approval Date: *JANUARY 2007*



**RECYCLED WATER USE SITE  
IDENTIFICATION DETAILS**

Revision: 1

RW-35

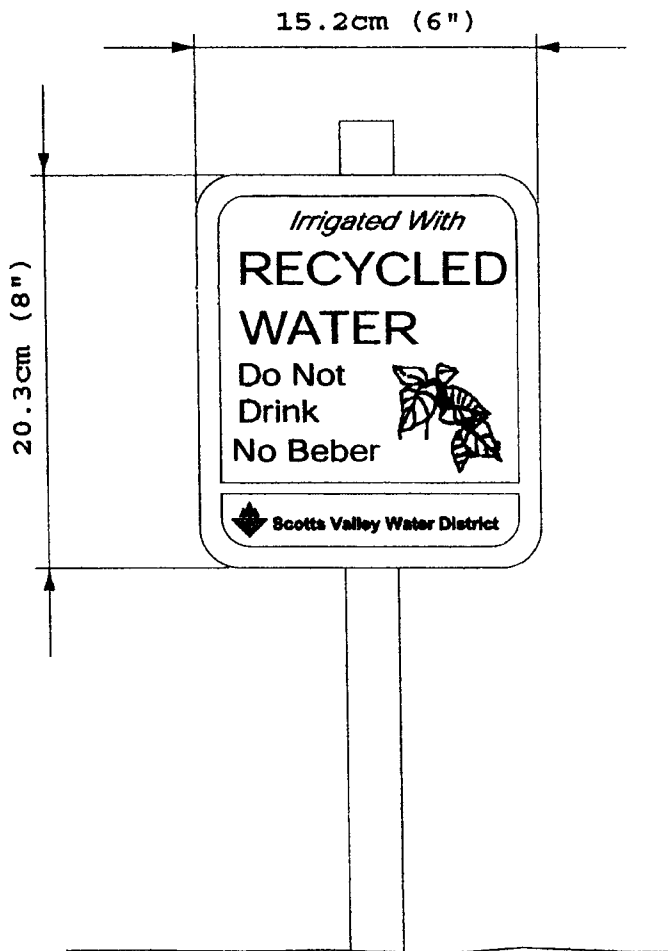

6" X 8" RECYCLED WATER METAL SIGN  
 SAFEWAY SIGN COMPANY (760) 246-7070  
 SAFEWAY PART NO. SWWD OR EQUAL

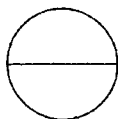

**Recycled Water Advisory Sign**

**Scotts Valley Water District**

Approval By: *John Hansing*

Approval Date: *JANUARY 2002*



**RECYCLED WATER USE SITE  
 IDENTIFICATION DETAILS**

Revision: 1

RW-36



FRONT



BACK

SAMPLE WARNING TAG. BACKGROUND PURPLE  
(PANTONE 512) WITH BLACK LETTERING.

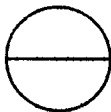

Identification of Recycled Water Warning Tag

**Scotts Valley Water District**

Approval By: *Jon Hansing*

Approval Date: *JANUARY 2002*



**RECYCLED WATER USE SITE  
IDENTIFICATION DETAILS**

Revision: 1

RW-37